

FL-811MP

120V SINGLE-HEAD OUTDOOR LIGHTING LUMINAIRE

Project _____
Location _____
Quote/ Ref # _____

The **FL-811MP** is an outdoor LED accent light with multiple beam and shroud options. It can individually rotate 360° and can be tilted 180° allowing for a more precise lighting scheme. Made of die-cast aluminum, it is extremely durable to ensure a longer lifetime. Its optimized heat dissipation allows the luminaire to be operated in extended lengths of time. Suitable for outdoor lighting such as building facades, gardens, lawns, tree accent lighting, and common outdoor areas.



SPECIFICATIONS

INPUT VOLTAGE	120V AC
WATTAGE	4W/ 8W
HOUSING	Die-cast Aluminum
GASKET	Silicone Rubber
FRONT COVER	Tempered Glass
LED OPTIC	Polycarbonate Lens
FINISH TYPE	AkzoNobel Powder Coating
DRIVER TYPE	Constant Current (Built-In)
AMBIENT TEMPERATURE	-20 ~ 45°C (-4 ~ 113°F)
IP RATING	IP65
CERTIFICATIONS	ETL

FEATURES

- 120V AC (No Transformer Needed)
- Available in 4W and 8W
- 360° Rotate | 180° Tilt
- Die-cast Aluminum Housing
- IP65 Outdoor/ Wet Rated
- Multiple Beam Patterns



MODEL	WATTS	STEM LENGTH	COLOR TEMP	OPTICS	SHROUD	FINISH	ACCESSORIES
FL-811MP	4 4W	18 18 in.	30K 3000K	15 15°	NS No Shroud	BK Black	HC Honeycomb Louver
	8 8W	36 36 in.	40K 4000K	25 25°	AS Angled Retractable	WH White	MR Marine Ambient Corosion Resistant
				35 35°	OS Open Straight Retractable	GR Gray	
				4020 H40° x V20°		BZ Bronze SI Silver	

FL-811MP

120V SINGLE-HEAD OUTDOOR LIGHTING LUMINAIRE

DIMENSIONS

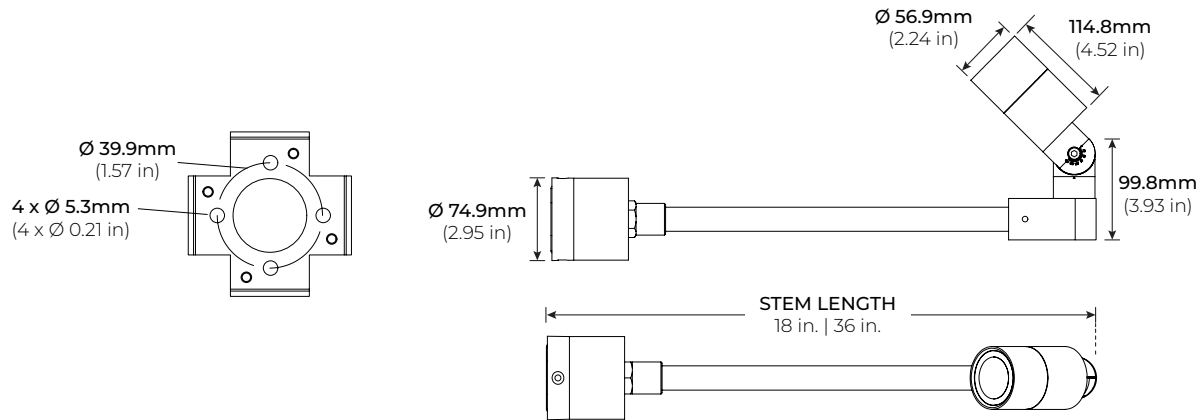

SHROUDS

AS
ANGLED RETRACTABLE

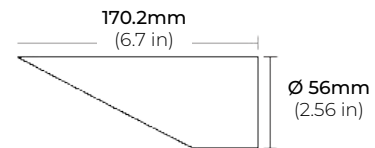

OS
OPEN STRAIGHT RETRACTABLE

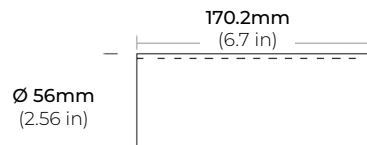

ACCESSORIES

HC
HONEYCOMB LOUVER

