

FL-720

OUTDOOR LIGHTING LUMINAIRE

Project _____
Location _____
Quote/ Ref # _____

The **FL-720** is an outdoor LED accent light with multiple beam and shroud options. It can rotate 360° and can be tilted 180° allowing for a more precise lighting scheme. Various accessories are available for different mounting options. Made of die-cast aluminum, it is extremely durable to ensure a longer lifetime. Its optimized heat dissipation allows the luminaire to be operated in extended lengths of time. Suitable for outdoor lighting such as building facades, gardens, lawns, tree accent lighting, and common outdoor areas



SPECIFICATIONS

INPUT VOLTAGE	120V AC
WATTAGE	15W
LUMEN OUTPUT	70Lm/ W
HOUSING	Die-cast Aluminum
GASKET	Silicone Rubber
FRONT COVER	Tempered Glass
LED OPTIC	Polycarbonate Lens
FINISH TYPE	AkzoNobel Powder Coating
DRIVER TYPE	Constant Current (Built-In)
AMBIENT TEMPERATURE	-20 ~ 45°C (-4 ~ 113°F)
IP RATING	IP65
CERTIFICATIONS	ETL

FEATURES

- 120V AC (No Transformer Needed)
- 15W
- Multiple Beam Patterns
- 360° Rotate | 180° Tilt
- Die-cast Aluminum Housing
- IP65 Outdoor/ Wet Rated
- Multiple Beam Patterns



MODEL	WATTS	COLOR TEMP	OPTICS	CRI	SHROUD	FINISH	ACCESSORIES	
FL-720	15 15W	27K 2700K	15 15°	80 Ra80	NS No Shroud	BLK Black	KC 4.5" Round Cover	HC Honeycomb Louver
		30K 3000K	25 25°		90 Ra90		AS Angled Glare Shield	WH White
		40K 4000K	40 40°	OS Straight Glare Shield		GR Gray	SHV High Voltage Ground Stake	PC Pole Clamp
		50K 5000K	AH H55° x V20°	BZ Bronze		PJB Tree Strap with Junction Box		
				HV H20° x V55°	SI Silver			

FL-720

OUTDOOR LIGHTING LUMINAIRE

DIMENSIONS

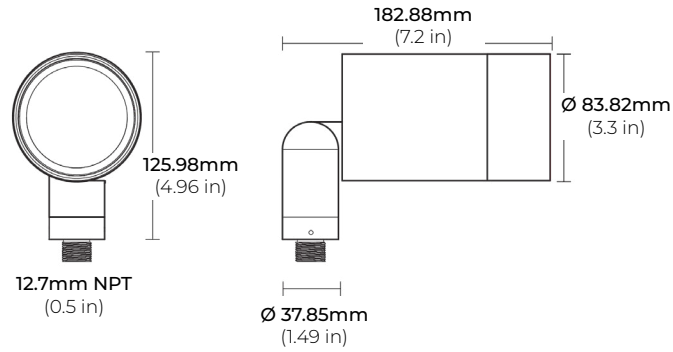

SHROUDS

AS
ANGLED RETRACTABLE

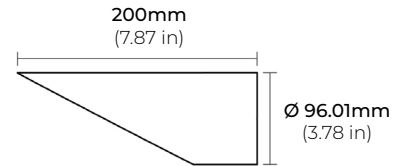

OS
OPEN STRAIGHT RETRACTABLE

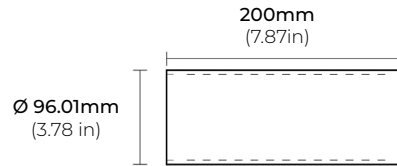

ACCESSORIES

FL700-KC
4.5" ROUND COVER

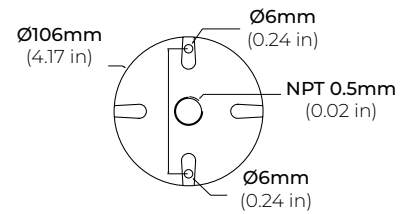

FL700-JB
JUNCTION BOX

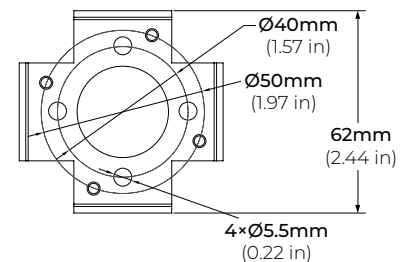
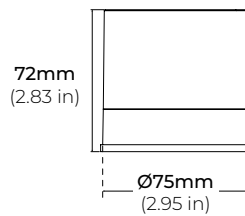
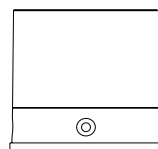

FL-720

OUTDOOR LIGHTING LUMINAIRE

ACCESSORIES

FL700-SHV
HIGH VOLTAGE GROUND STAKE

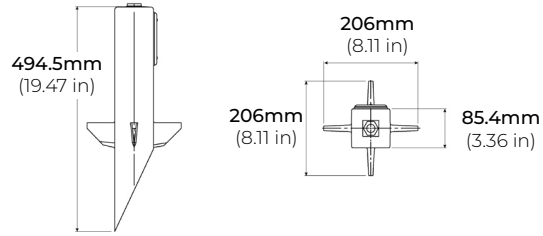

FL700-PJB
TREE STRAP WITH JUNCTION BOX

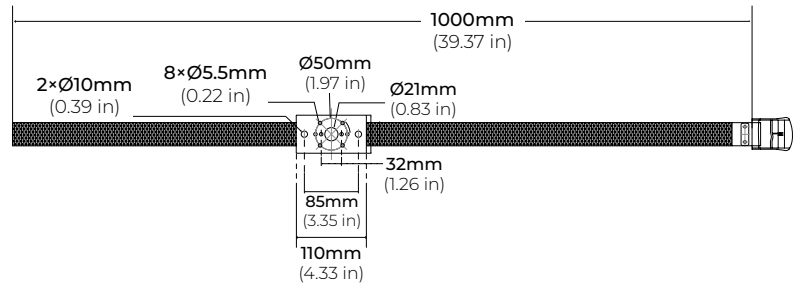

FL700-HC
HONEYCOMB LOUVER

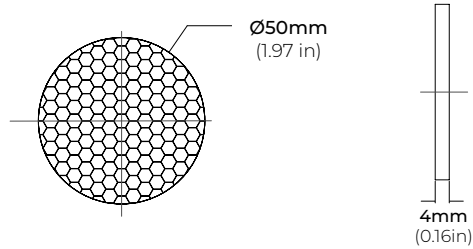

FL700-PC
POLE CLAMP

